



# Agreement on International Humane Trapping Standards



Certified trap identification sheet

Commercial name of trap :

**BELISLE FOOTSNARE**

FEBRUARY 1, 2015

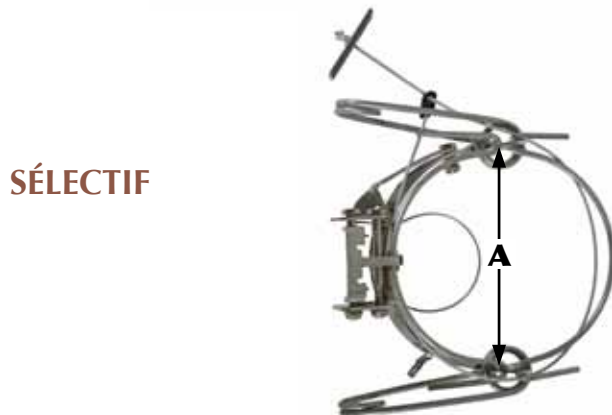
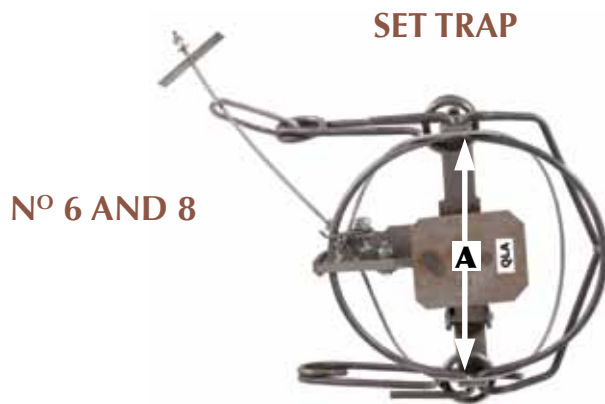

## AIHTS CERTIFICATION

MODEL	NUMBER	TARGET SPECIES	INSIDE MEASUREMENT (A) TAKEN ON THE SET TRAP
N° 6	QLA	Canada Lynx, Coyote, Bobcat, Red fox	5 <sup>3</sup> / <sub>4</sub> inch (148 mm)
N° 8	QWA	Wolf	7 <sup>3</sup> / <sub>4</sub> inch (197 mm)
SÉLECTIF	QYB	Canada Lynx, Coyote, Bobcat, Red fox	5 <sup>3</sup> / <sub>4</sub> inch (148 mm)

# Certified trap identification sheet

FEBRUARY 1, 2015

Commercial name of trap :

**BELISLE FOOTSNARE**



LOCATION OF THE  
CERTIFICATION NUMBER



# Agreement on International Humane Trapping Standards



Certified trap identification sheet

Commercial name of trap :

**BRIDGER ALASKAN NO 5**

FEBRUARY 1, 2015



OFFSET, LAMINATED



RUBBER JAWS



MODEL	AIHTS CERTIFICATION		INSIDE MEASUREMENT TAKEN ON THE SAME JAW (SET TRAP)	
	NUMBER	TARGET SPECIES	(A)	(B)
OFFSET, LAMINATED	QWE	Wolf	7 inch (176 mm)	7 <sup>1</sup> / <sub>8</sub> inch (180 mm)
RUBBER JAWS	QWF	Wolf	6 <sup>7</sup> / <sub>8</sub> inch (175 mm)	6 <sup>7</sup> / <sub>8</sub> inch (175 mm)



# Agreement on International Humane Trapping Standards



Certified trap identification sheet

Commercial name of trap :

**BRIDGER BRAWN**

FEBRUARY 1, 2015



MODEL	AIHTS CERTIFICATION		INSIDE MEASUREMENT TAKEN ON THE SAME JAW (SET TRAP)	
	NUMBER	TARGET SPECIES	(A)	(B)
N° 9 RUBBER JAWS	AWA	Wolf	7 1/2 inch (190 mm)	8 1/16 inch (205 mm)



# Agreement on International Humane Trapping Standards



Certified trap identification sheet

Commercial name of trap :

## BRIDGER "COIL SPRINGS" OFFSET + LAMINATED JAWS

FEBRUARY 1, 2015

SET TRAP

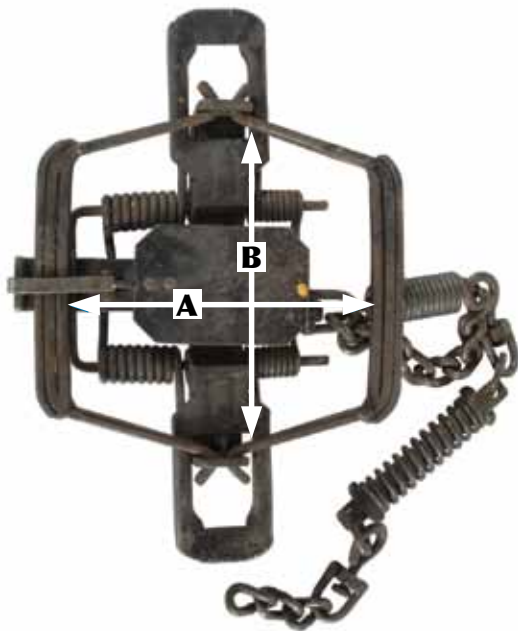

CLOSED TRAP

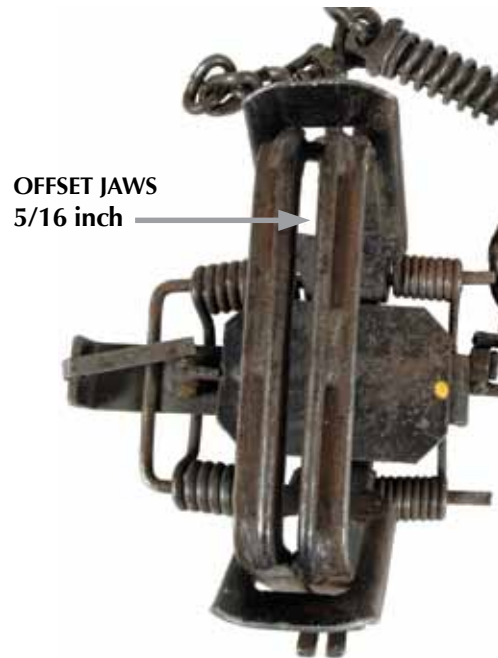

SEE REVERSE FOR MORE COMPONENTS DETAILS

MODEL	AIHTS CERTIFICATION		INSIDE MEASUREMENT TAKEN ON THE SAME JAW (SET TRAP)	
	NUMBER	TARGET SPECIES	WIDTH (A)	HEIGHT (B)
N° 3 4 SPRINGS		Coyote	5 <sup>3</sup> / <sub>4</sub> inch (146 mm)	5 <sup>7</sup> / <sub>16</sub> inch (138 mm)

# Certified trap identification sheet

FEBRUARY 1, 2015

Commercial name of trap :

**BRIDGER "COIL SPRINGS"  
OFFSET + LAMINATED JAWS**



**ROUNDED LAMINATIONS**

ON TOP END  
OF JAW 3/16 inch

ON UNDERSIDE  
OF JAW 1/4 po inch

JAW



**ANCHORING SWIVEL CENTRE  
(MOUNTED ON A BASE PLATE)**





# Agreement on International Humane Trapping Standards



Certified trap identification sheet

Commercial name of trap :

**DUFFER**

FEBRUARY 1, 2015

## SET TRAP



### AIHTS CERTIFICATION

MODEL	NUMBER	TARGET SPECIES	WIDTH (A)
RACCOON TRAP	ORH	Raccoon	2 1/2 inch (60 mm)



# Agreement on International Humane Trapping Standards



Certified trap identification sheet

Commercial name of trap :

**DUKE DP**

FEBRUARY 1, 2015

## CLOSED TRAP



### AIHTS CERTIFICATION

MODEL	NUMBER	TARGET SPECIES	WIDTH (A)
DUKE DP	QRX	Raccoon	1 1/4 inch (30 mm)





# Agreement on International Humane Trapping Standards



Certified trap identification sheet

Commercial name of trap :

**EGG TRAP**

FEBRUARY 1, 2015

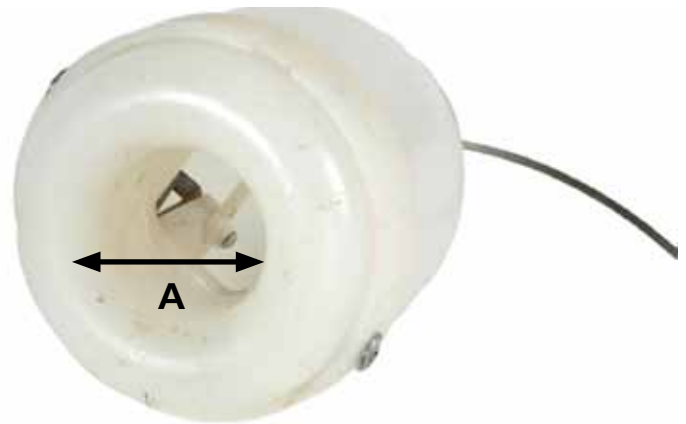

### AIHTS CERTIFICATION

MODEL	NUMBER	TARGET SPECIES	WIDTH (A)
EGG TRAP		Raccoon	1 1/2 inch (38 mm)



# Agreement on International Humane Trapping Standards



Certified trap identification sheet

Commercial name of trap :

**LIL' GRIZZ GETRZ**

FEBRUARY 1, 2015

## SET TRAP



### AIHTS CERTIFICATION

MODEL	NUMBER	TARGET SPECIES	WIDTH (A)
LIL' GRIZZ GETRZ	ORI	Raccoon	1 1/4 inch (30 mm)



# Agreement on International Humane Trapping Standards



Certified trap identification sheet

Commercial name of trap :

**LIVESTOCK PROTECTION**

FEBRUARY 1, 2015

## SET TRAP

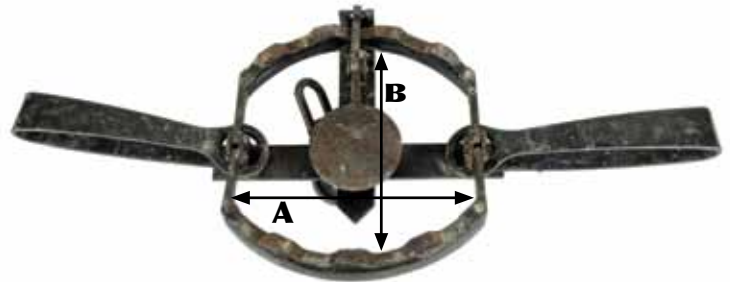

AIHTS CERTIFICATION			INSIDE MEASUREMENT TAKEN ON THE SAME JAW (SET TRAP)	
MODEL	NUMBER	TARGET SPECIES	WIDTH (A)	HEIGHT (B)
EZ GRIP N° 7	QWC	Wolf	6 inch (152 mm)	6 1/4 inch (160 mm)



# Agreement on International Humane Trapping Standards



## Certified trap identification sheet

Commercial name of trap :

FEBRUARY 1, 2015

**MB 750**



MODEL	AIHTS CERTIFICATION		INSIDE MEASUREMENT TAKEN ON THE SAME JAW (SET TRAP)	
	NUMBER	TARGET SPECIES	(A)	(B)
OS <sup>3</sup> / <sub>8</sub> "	QWG	Wolf	7 <sup>1</sup> / <sub>4</sub> inch (184 mm)	7 inch (180 mm)



# Agreement on International Humane Trapping Standards



Certified trap identification sheet

Commercial name of trap :

**ONEIDA VICTOR "COIL SPRINGS"  
OFFSET + LAMINATED JAWS**

FEBRUARY 1, 2015

SET TRAP

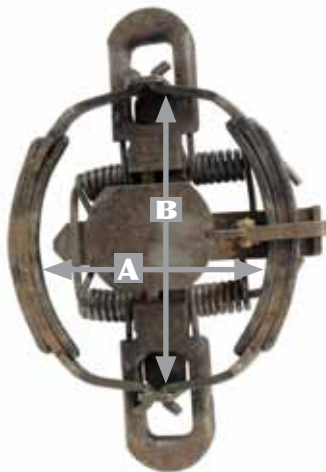

CLOSED TRAPS



OFFSET  
JAWS  
3/16 INCH

4 SPRINGS



2 SPRINGS

## SEE REVERSE FOR MORE COMPONENTS DETAILS

MODEL	AIHTS CERTIFICATION		INSIDE MEASUREMENT TAKEN ON THE SAME JAW (SET TRAP)	
	NUMBER	TARGET SPECIES	WIDTH (A)	HEIGHT (B)
N° 1.75 2 SPRINGS	VDB	Bobcat	4 1/2 inch (115 mm)	4 5/8 inch (118 mm)
N° 1.75 4 SPRINGS	QYC	Coyote	4 1/2 inch (115 mm)	4 5/8 inch (118 mm)
N° 3 2 SPRINGS	QYE	Coyote, Bobcat	4 3/4 inch (121 mm)	6 inch (153 mm)
N° 3 4 SPRINGS	QYD	Coyote	4 3/4 inch (121 mm)	6 inch (153 mm)

Certified trap identification sheet

FEBRUARY 1, 2015

Commercial name of trap :  
**ONEIDA VICTOR "COIL SPRINGS"  
OFFSET + LAMINATED JAWS**

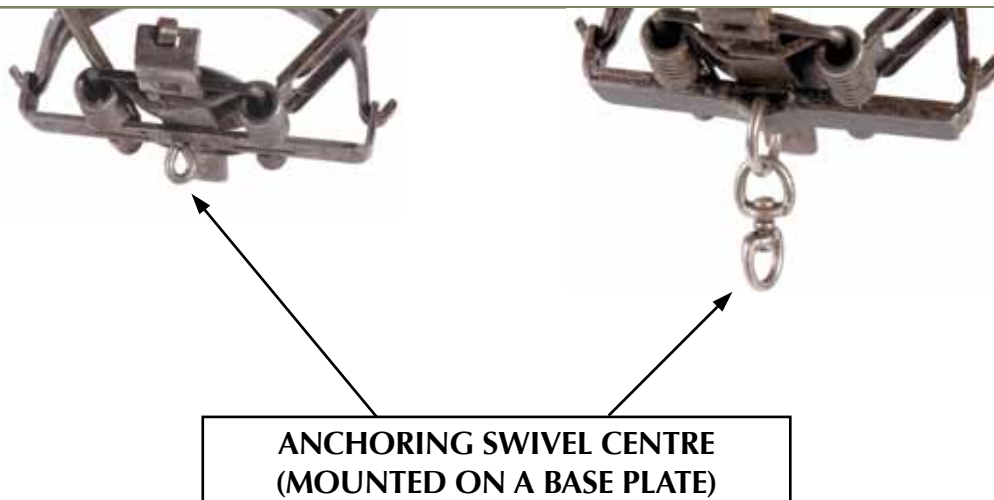
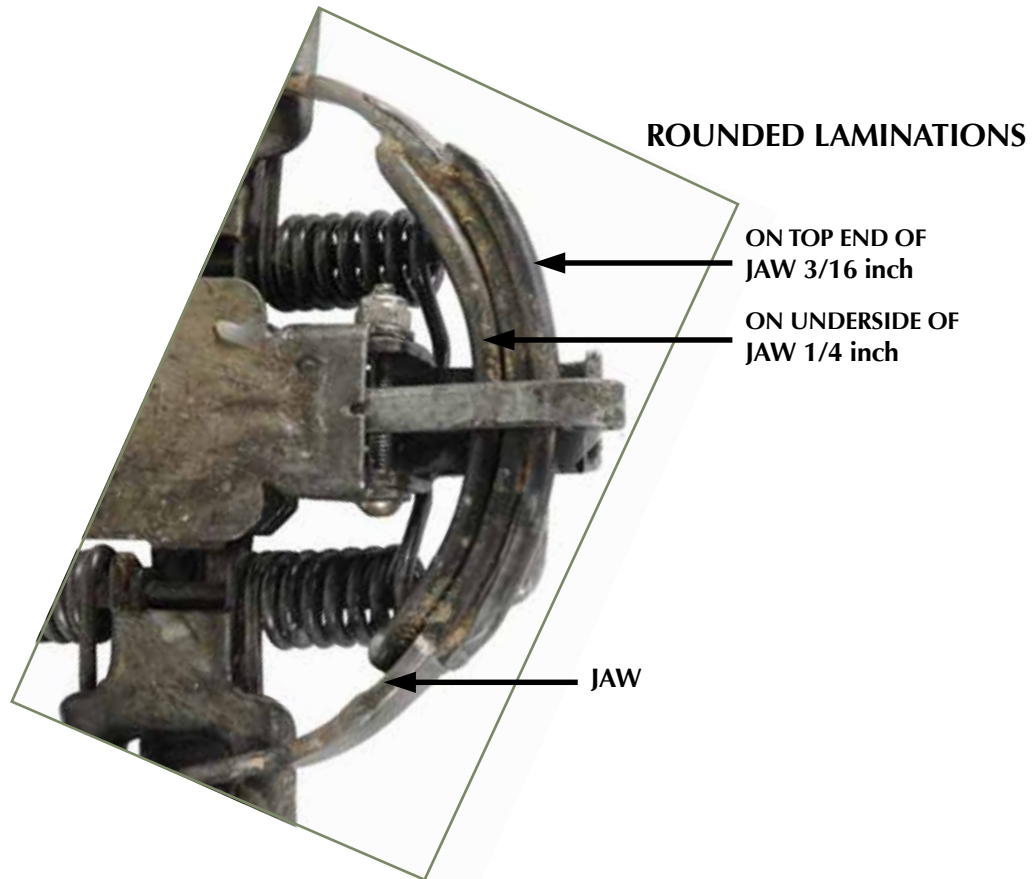





# Agreement on International Humane Trapping Standards



Certified trap identification sheet

Commercial name of trap :

FEBRUARY 1, 2015

**ONEIDA VICTOR  
"COIL SPRINGS" NO 3  
NON-OFFSET + LAMINATED JAWS**

SET TRAP

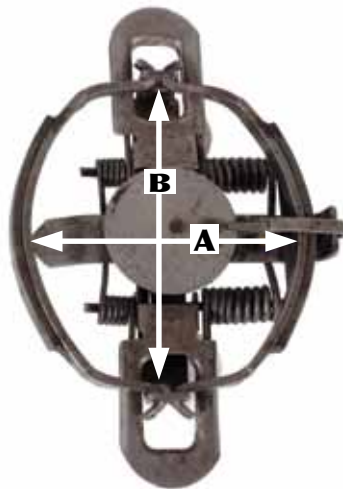

CLOSED TRAP

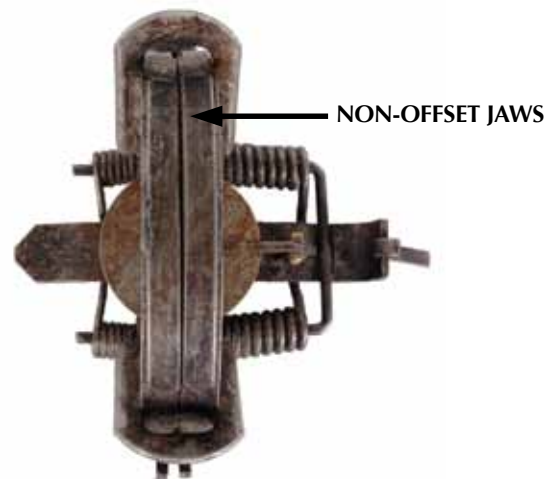

SEE REVERSE FOR MORE COMPONENTS DETAILS

MODEL	AIHTS CERTIFICATION		INSIDE MEASUREMENT TAKEN ON THE SAME JAW (SET TRAP)	
	NUMBER	TARGET SPECIES	WIDTH (A)	HEIGHT (B)
N° 3 4 SPRINGS	QLC	Canada Lynx	5 1/4 inch (133 mm)	6 inch (153 mm)

# Certified trap identification sheet

FEBRUARY 1, 2015

Commercial name of trap :  
**ONEIDA VICTOR**  
**"COIL SPRINGS" NO 3**  
**NON-OFFSET + LAMINATED JAWS**

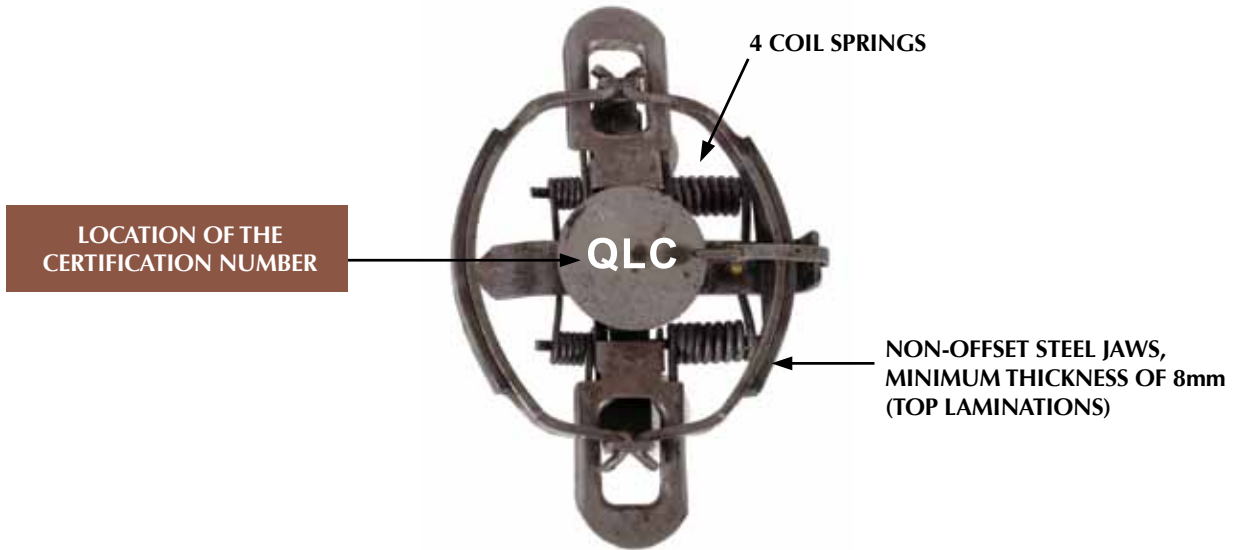

## CHARACTERISTICS

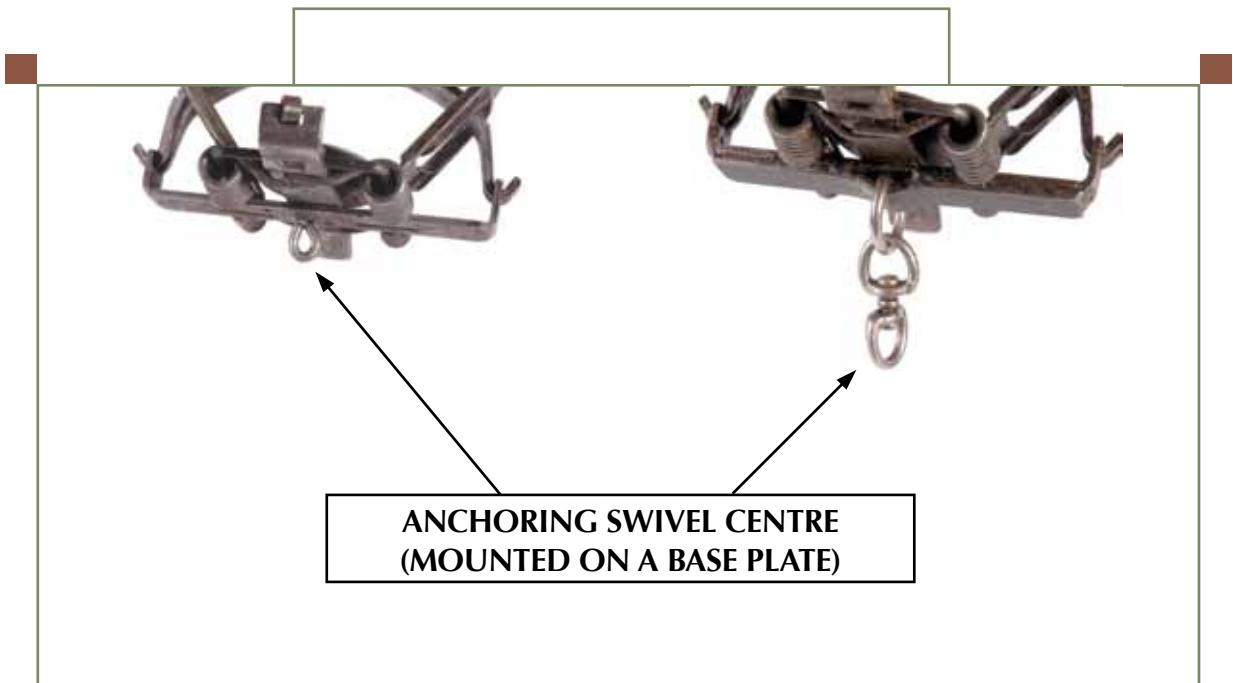



# Agreement on International Humane Trapping Standards



Certified trap identification sheet

Commercial name of trap :

**ONEIDA VICTOR  
"SOFT CATCH"**

FEBRUARY 1, 2015

SET TRAP

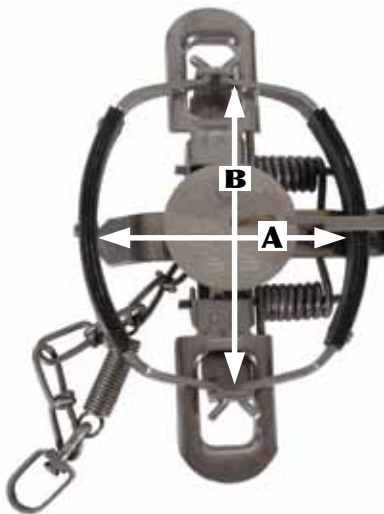

CLOSED TRAP



4 SPRINGS

2 SPRINGS

MODEL	AIHTS CERTIFICATION		INSIDE MEASUREMENT TAKEN ON THE SAME JAW (SET TRAP)	
	NUMBER	TARGET SPECIES	WIDTH (A)	HEIGHT (B)
N° 1.5 2 SPRINGS	VYA	Coyote	4 <sup>5</sup> / <sub>8</sub> inch (120 mm)	4 <sup>5</sup> / <sub>8</sub> inch (120 mm)
N° 1.5 4 SPRINGS	VDA	Coyote, Bobcat	4 <sup>5</sup> / <sub>8</sub> inch (120 mm)	4 <sup>5</sup> / <sub>8</sub> inch (120 mm)
N° 3 2 SPRINGS	QY1	Canada Lynx, Coyote, Bobcat	5 inch (127 mm)	6 <sup>1</sup> / <sub>8</sub> inch (156 mm)
N° 3 4 SPRINGS	QLB	Canada Lynx, Bobcat	5 inch (127 mm)	6 <sup>1</sup> / <sub>8</sub> inch (156 mm)

# Certified trap identification sheet

FEBRUARY 1, 2015

Commercial name of trap :  
**ONEIDA VICTOR**  
**"SOFT CATCH"**

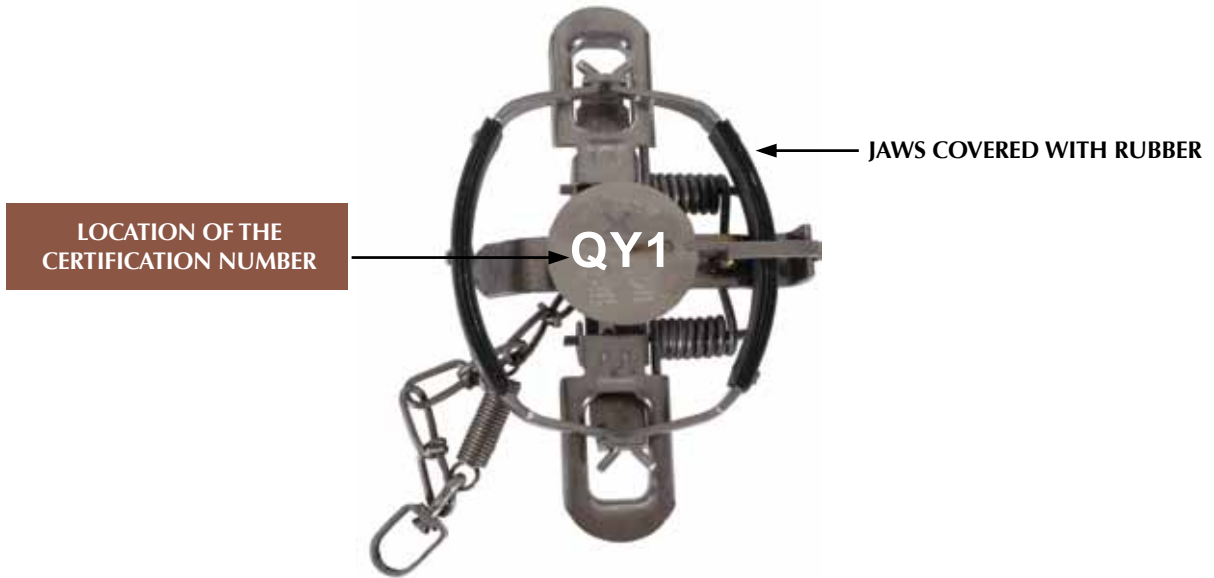

## CHARACTERISTICS

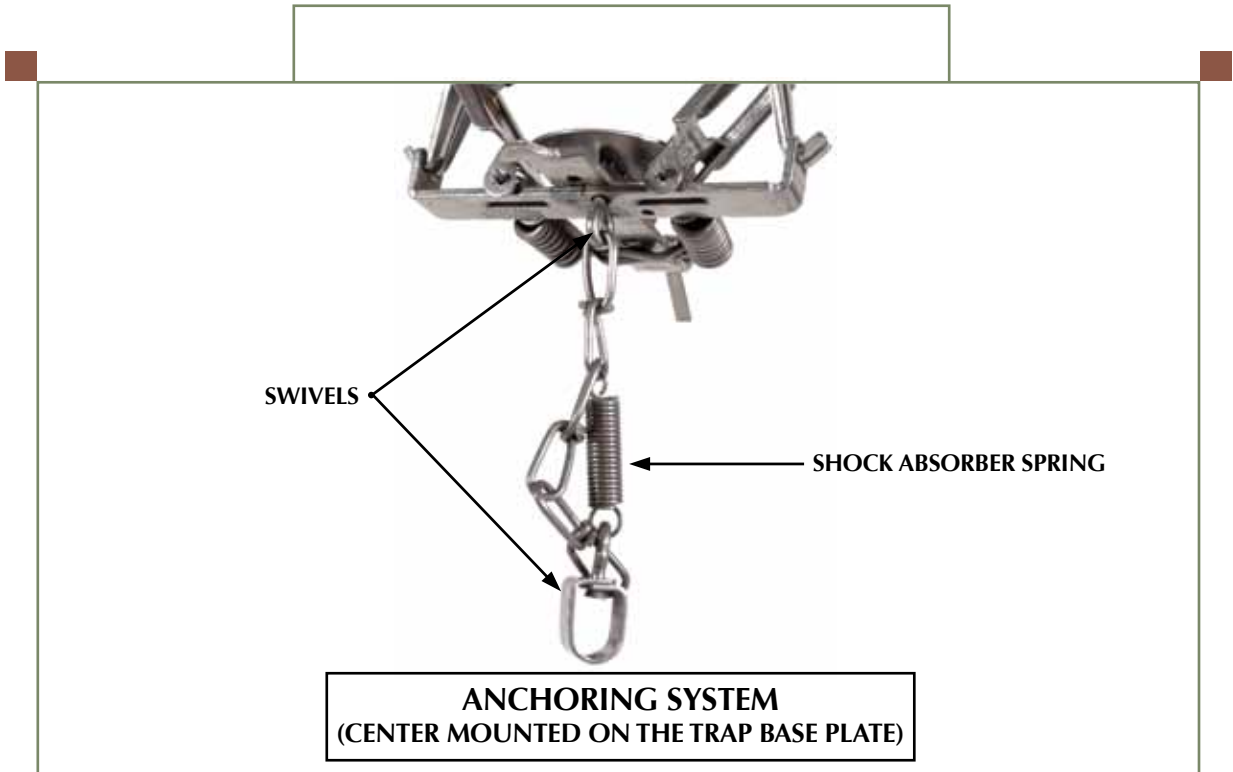



# Agreement on International Humane Trapping Standards



Certified trap identification sheet

Commercial name of trap :

FEBRUARY 1, 2015

## ONEIDA VICTOR "SOFT CATCH" NO 3 (MODIFIED FOR WOLF)



4 coil springs

Jaws anchoring point strengthened by welding points

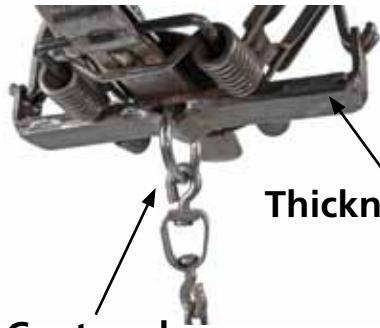

Thickness of 8 mm

Centered Swivel



AIHTS CERTIFICATION			
MODEL	NUMBER	TARGET SPECIES	CHARACTERISTICS
3 SC (MODIFIED)	QWB	Wolf	<ul style="list-style-type: none"> <li>• 4 coil springs</li> <li>• Minimum 8 mm thick base plate</li> <li>• Centered swivel</li> </ul>



# Agreement on International Humane Trapping Standards



Certified trap identification sheet

Commercial name of trap :

**RUDY RED WOLF**

FEBRUARY 1, 2015



MODEL	AIHTS CERTIFICATION		INSIDE MEASUREMENT TAKEN ON THE SAME JAW (SET TRAP)	
	NUMBER	TARGET SPECIES	(A)	(B)
N° 4 1/2	QWD	Wolf	6 3/8 inch (162 mm)	7 3/8 inch (185 mm)